

midi LOGGER

# GL220 Quick Start Guide

GL220-UM-852



Thank you for choose the midi LOGGER GL220.  
This Quick Start Guide describes the basic operations.  
Please refer to the manual (PDF) in the CD-ROM for more information.

## Checking the Outer Casing

After unpacking, check the GL220's Exterior to make sure that there are no crack or other damage before use.

## Checking the Accessories

- o Quick Start Guide : 1
- o CD-ROM : 1
- o AC cable/AC adapter : 1

Don't forget to check the setting



## Setting and Checking the AC Line Frequency

Set the AC line frequency in the "OTHR" menu. This setting (50 or 60 Hz) affects the noise reduction performance of the device.

# GL220 Contents

Nomenclature.....	2
Connection Procedures.....	3
Precautions to Observe When Performing Measurement .....	4
Descriptions of the Control Panel Keys .....	5
Descriptions of the Menu Screens .....	8
Measurement Procedure.....	9
1. Preparations : How to Make the Preparations Required for Data Capture....	9
2. Setup : How to Make the Settings.....	10
3. Data Capture : How to Capture Data .....	13
4. Data Replay : How to Replay Captured Data .....	14
Convenient Functions.....	15
Trigger Functions to Control Data Capture Start/Stop Operations.....	15
Span, Position and Trace Functions to Adjust the Waveform Display.....	17
Specifications.....	18
Standard Specifications .....	18
External Input/Output Functions .....	18
Input Unit Specifications .....	19
Installation Guide.....	20

# GL220 Nomenclature

## Top Panel

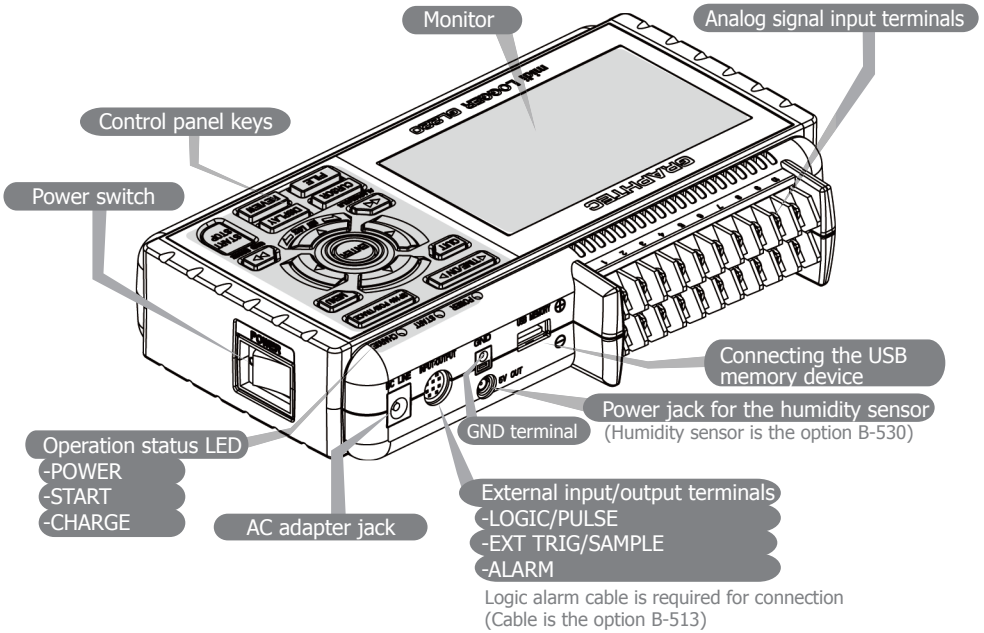

## Bottom Panel

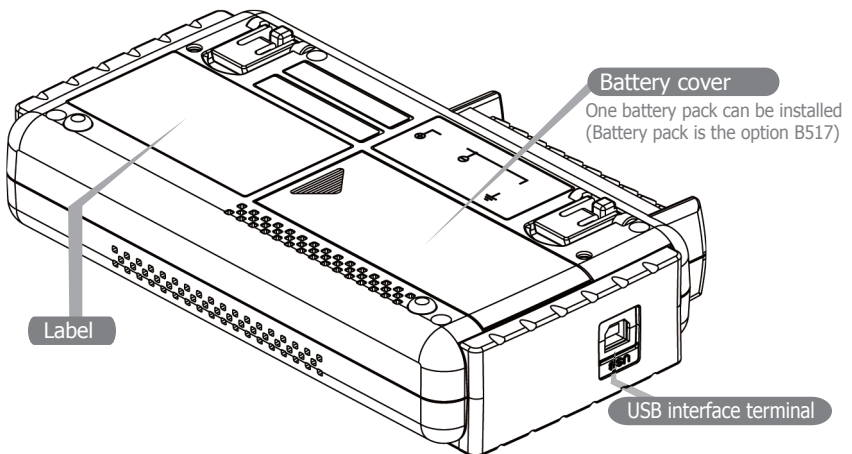

# GL220 Connection Procedures

## Connecting the AC Adapter

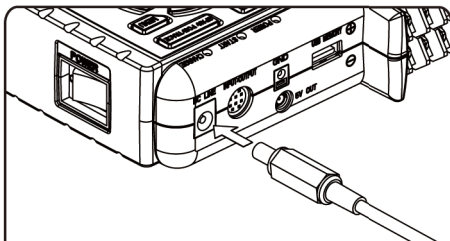

Connect the output side of the AC adapter to the connector indicated as "DC LINE" on the GL220.

## Connecting the Grounding Cable

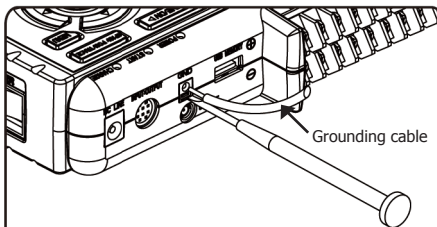

Use a flathead screwdriver to push the button above the ground terminal while connecting the grounding cable to the GL220. Connect the other end of the cable to ground.

## Making Connections to the Analog Input Terminals

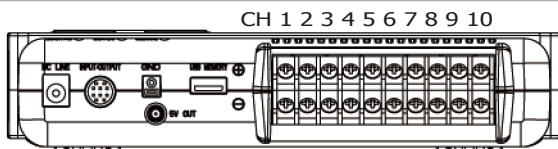

### Direct voltage input

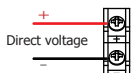

### Direct current input

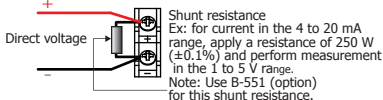

### Thermocouple input

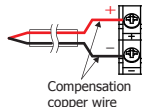

Note: Connect wires to the desired terminals according to the terminal numbers on top of the terminal block.

## Making Connections to the External Input/Output Terminals

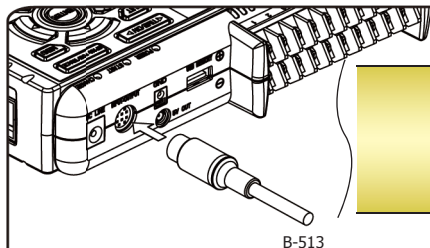

### Connection diagram

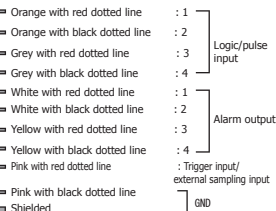

\*B-513 (sold separately) cable is required for external input/output.  
(For logic/pulse input, alarm output, trigger input, external sampling input)

# Precautions to Observe When Performing Measurement

## Maximum input voltage

If a voltage exceeding the specified value is input, the semiconductor relay in the input section will be damaged. Never input a voltage exceeding the specified value even for a moment.

<Between +/- terminals (A) >

- Maximum input voltage : 60Vp-p

<Between input terminal/input terminal (B) >

- Maximum input voltage : 60Vp-p
- Withstand voltage : 350 Vp-p at 1 minute

<Between input terminal/GND (C) >

- Maximum input voltage : 60Vp-p
- Withstand voltage : 350 Vp-p at 1 minute

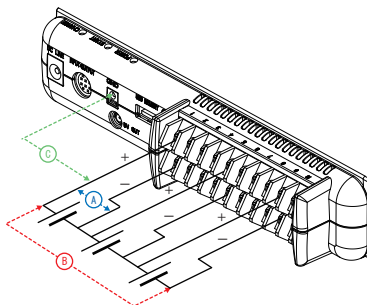

## Warming-up

GL220 requests to have approximately 30 minutes warm-up in order to have the specified performance.

## Unused channels

The analog input section has high impedance.

If it is open, measured value may vary due to noise.

In such a case, set to "Off" unused channels in the AMP setting menu or short the + and - terminals.

## Noise countermeasures

If measured values fluctuate due to extraneous noise, conduct the following countermeasures.

(Results may differ according to noise type.)

Ex 1 : Connect the GL220's GND to ground.

Ex 2 : Connect GL220's GND to measurement object's GND.

Ex 3 : In the AMP settings menu, set filter to any setting other than "OFF".

Ex 4 : Operate GL220 with batteries (Option: B-517).

Ex 5 : Set the sampling interval which enables GL220's digital filter (see table below).

Number of Measuring Channels*	Allowed Sampling Interval	Sampling Interval which enables Digital Filter
1 channel or less	10 msec or slower**	50 msec or slower
2 channels or less	20 msec or slower**	125 msec or slower
5 channels or less	50 msec or slower**	250 msec or slower
10 channels or less	100 msec or slower	500 msec or slower

\*Number of Measuring Channels" is the number of channels in which input settings are NOT set to "OFF".

\*\*Temperature cannot be measured when the sampling interval is set to 10, 20, or 50 ms.

# GL220 Descriptions of the Control Panel Keys

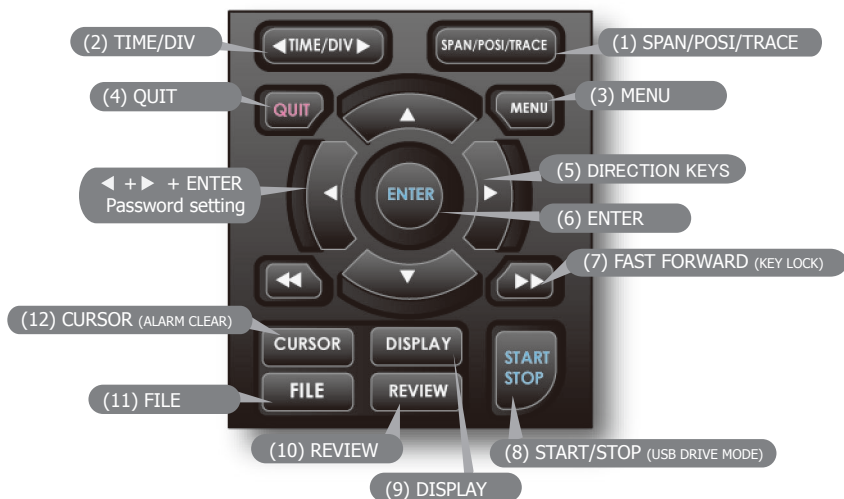

## 1. SPAN/POSI/TRACE

This key enables SPAN, POSITION, and TRACE settings to be made independently for each channel. Each time this key is pressed, the display mode changes in the sequence shown below. Use the ▲ and ▼ keys to select the channel, and the ◀ and ▶ keys to change the setting values.

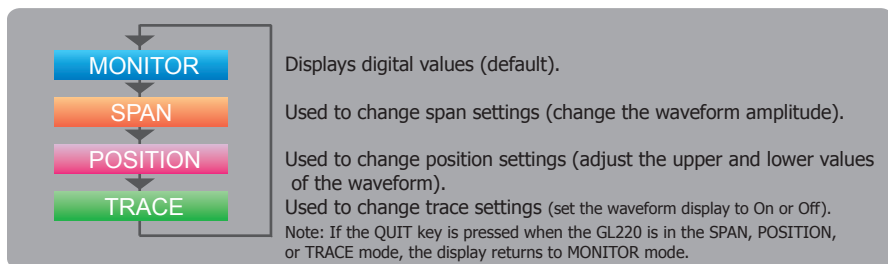

## 2. TIME/DIV

Press the TIME/DIV key to change the time axis display range on the waveform screen.

### 3. MENU

Press the MENU key to open a setup menu. Each time this key is pressed, the setup screen tabs change in the sequence shown below.

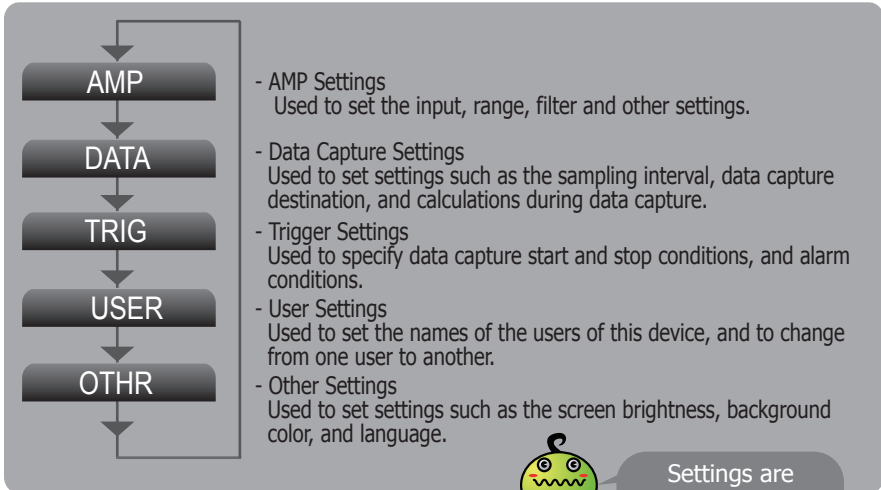

Settings are complete !

### 4. QUIT (LOCAL)

Press the QUIT key to cancel the settings and return them to their default status. If the device is in the Remote (Key Lock) status that the device is operated by the computer via the interface,, press this key to return the device to the normal operating status (Local).

### 5. Keys (DIRECTION KEYS)

These keys are used to select menu setup items, to make span settings in the digital display area, to move the cursors during a data replay operation, and so forth.

### 6. ENTER

Press the ENTER key to enter the settings made in the setup menus, and to confirm your settings.

### 7. Keys (KEY LOCK)

These keys are used to move the cursor at high speed during a data replay operation, and to change the operation mode in the file settings box. Hold down both keys simultaneously for at least two seconds to enable key lock status. To cancel key lock status, press them again for at least two seconds.

The key lock status can be confirmed by the status of the key lock lamp on the monitor.

Note: Pressing these keys simultaneously with the ◀ key + ENTER + ▶ key enables password protection for the key lock operation.

## 8. START/STOP (USB DRIVE MODE)

Press the START/STOP key to perform start and stop of a data capture while the GL220 is in the Free Running status. If this key is held down while the power to the GL220 is turned on, the GL220 goes into USB Drive Mode.

Note: Refer to the User's Manual in the supplied CD-ROM for more information on the setting.

## 9. DISPLAY

Press the DISPLAY key



Many display modes are available !

Waveform + Digital

Waveform + Digital : This is the default screen when the GL220 is turned on, and both waveforms and digital values are displayed. The screen settings can also be changed by using the SPAN/POSITION/TRACE key.

Expanded Waveform

Expanded Waveform : Displays waveforms only.

Digital + Calc

Digital + Calc : Displays large-size digital values and two types of calculation processing results. The calculation settings are made in the "DATA" menu.  
Use the << key or >> key to switch digital display modes.

## 10. REVIEW

Press the REVIEW key to replay captured data. If the GL220 is in the Free Running status, data files that have already been captured are replayed. If the GL220 is still capturing data, the data is replayed in a 2-screen format.

Note: A data replay operation will not be performed if data has not been captured.

## 11. FILE

Press the FILE key to save data to the GL220's internal memory or a USB memory device.

## 12. CURSOR (ALARM CLEAR)

Press the CURSOR key to switch between the A and B cursors during a data replay operation. If the Alarm setting has been specified as "Alarm Hold", press this key to clear the alarm. The alarm settings are made in the "TRIG" menu.



# GL220 Descriptions of the Menu Screens

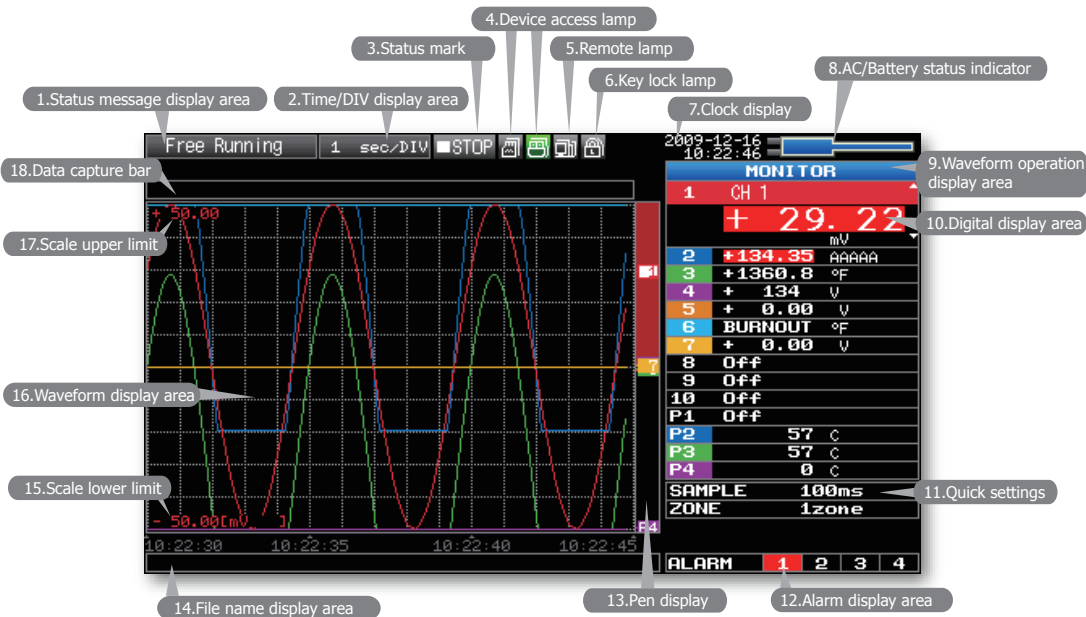

- 1. Status message display area : Displays the operating status.
- 2. Time/DIV display area : Displays the current time scale.
- 3. Status mark : Displays the status mark.
- 4. Device access lamp : Turns red while the internal memory or USM memory is in access. Turns green when a USB memory device has been inserted.
- 5. Remote lamp : Displays the remote status. (Yellow = Remote status, white = Local status)
- 6. Key lock lamp : Displays the key lock status. (Yellow = keys locked, white = not locked)
- 7. Clock display : Displays the current date and time.
- 8. AC/Battery status indicator : Displays the following icons to indicate the operating status of the AC power and the battery. (see right figure)  
Note: Use this indicator as a guideline because remaining battery power is an estimate. This indicator does not guarantee the operating time with battery.
- 9. Waveform operation display area : Displays the mode selected by the SPAN/POSITION/TRACE key.
- 10. Digital display area : Displays the input values for each channel. The ▼ and ▲ keys can be used to select the active channel (enlarged display). Moreover, the selected active channel is displayed at the very top of the waveform display.
- 11. Quick settings : Displays items that can be easily set. The ▲ and ▼ keys can be used to make a Quick settings item active, and the ◀ and ▶ keys to change the values.
- 12. Alarm display area : Displays the status of the alarm output. (Red = alarm generated, white = alarm not generated)
- 13. Pen display : Displays the signal positions, trigger positions, and alarm ranges for each channel. (see right figure)
- 14. File name display area : Displays the data capture file name during the data capture operation. When data is being replayed, the display position and cursor information is displayed here.
- 15. Scale lower limit : Displays the lower limit of the scale of the currently active channel.
- 16. Waveform display area : The input signal waveforms are displayed here.
- 17. Scale upper limit : Displays the upper limit of the scale of the currently active channel.
- 18. Data capture bar : Indicates the remaining capacity of the capture media during data capture. When data is being replayed, the display position and cursor information is displayed here.

**Status mark**

- STOP Free Running status
- REC Trigger waiting status
- REC Capture end status
- REC Capturing recording status
- ▶ PLAY Data replay status

**AC/Battery Indicator**

- When the AC power supply is being used
- Battery power: 100 - 91%
- Battery power: 90 - 61%
- Battery power: 60 - 31%
- Battery power: 30 - 11%
- Battery power: 10% or less

**Trigger position**      **Alarm range**

# GL220 Measurement Procedure

In this section we will provide a simple explanation of the data capture procedure:

Preparations -> Setup -> Data Capture -> Data Replay.

Voltage measurement is performed here.

Purpose of data capture : To measure the temperature of the target objects  
Temperature Range : T Thermocouple  
Voltage range : 1V  
Sampling interval : 1 sec  
Data save destination : Internal memory device

## 1. Preparations : How to Make the Preparations Required for Data

- 1.Connect Thermocouple to the CH 1 terminal (Temperature).
- 2.Connect wire to the CH 2 terminal (Voltage).
- 3.Connect the AC power supply.
- 4.Turn on the power supply.

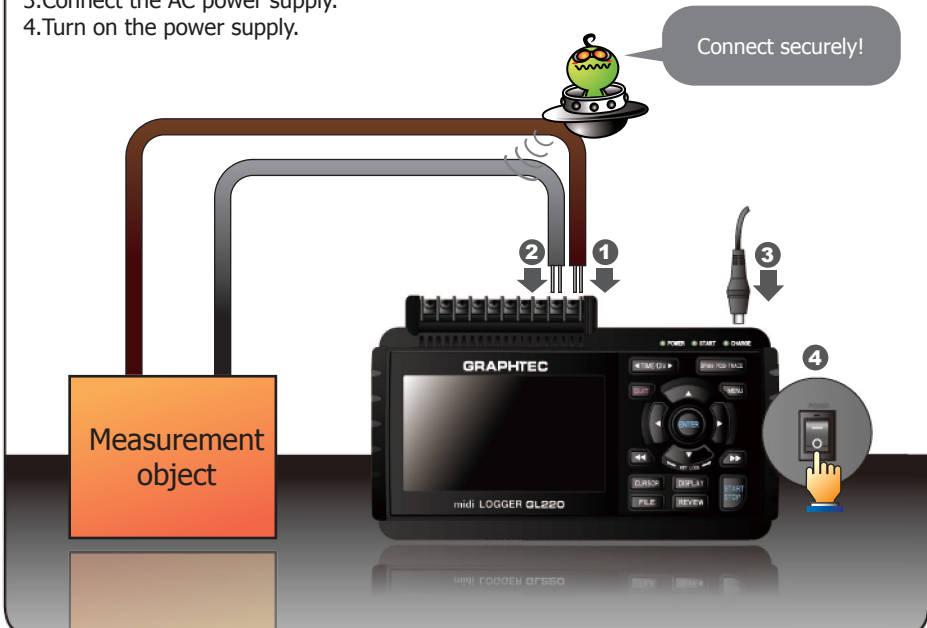

## 2. Setup: How to Make the Settings

Make the settings required for data capture. Here we will make only those settings that are minimum requirement. The other settings will be not changed from the factory default settings.

### Basic Setup Menu Operation

Points to Remember!



The  $\blacktriangleleft\blacktriangleright$  key, the ENTER key, and the QUIT key are used to set the condition on the setup menu. The current position of the cursor on the setup menu is displayed in green. Use the  $\blacktriangleleft\blacktriangleright$  keys to move the cursor. If you press the ENTER key at the cursor position, a selection menu or a box of entering value for selected item is displayed. If you press the QUIT key, the screen closes and the settings are canceled.

- Examples of selection menu operations (AMP screen)

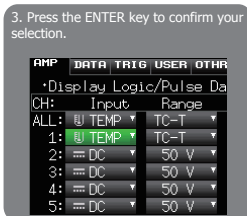
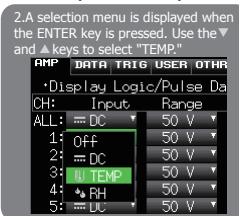
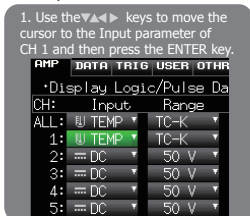

(Note: Select "DC" for voltage measurement, and "Humidity" for humidity measurement.)



1. Press the MENU key to display the setup menu screen.

2. Set Input to "TEMP" and Range to "TC-T" for CH1, and set Input to "DC" and Range to "1V" for CH2.

(1) Move the cursor to CH1 "Input" and select "TEMP" and then move it to "Range" and select "TC-T"

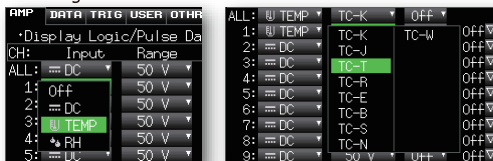

(2) In the same way, move the cursor to CH2 "Input" and select "DC" and then move it to "Range" and select "1V."

3. Select "Off" for all the other channels.

(1) Using the procedure described above, select "Off" for CH 3 to CH 10.

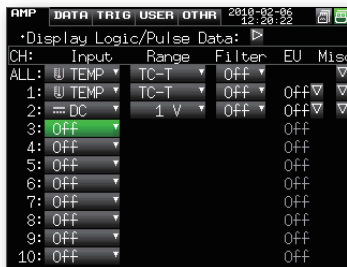

4. Press the MENU key and open the "DATA" menu.



5. Set the sampling interval to "1s".

Move the cursor to "Sampling" and then select "1s".

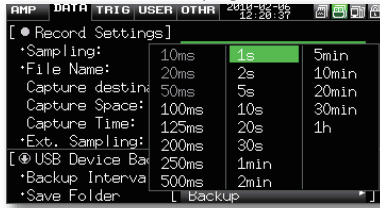

6. Set the Data Capture Destination to "Internal memory".

Here the "TEST" folder is created in the Internal memory device, and then destination for the captured data is set to the TEST folder.

(1) Move the cursor to the File Name parameter and then press the ENTER key.

(2) Move the cursor to the <MEM> item in the following screen, press the ENTER key.

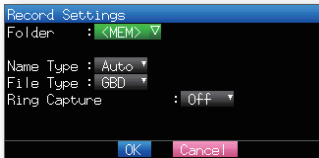
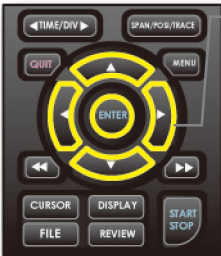

(3) The file settings box shown in the following screen opens. This box is used to specify file names for the GL220's internal memory and for the USB memory device.

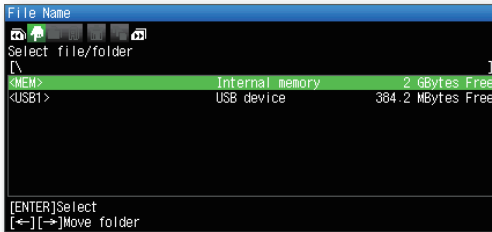

Note: <USB1> is displayed when USB memory is installed.

(4) Move the cursor to <MEM> and then press the ► key.

Press ►► the key to move the cursor to and then press the ENTER key.

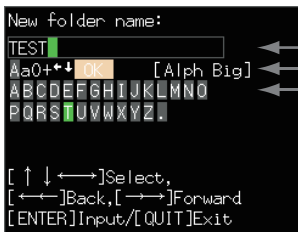
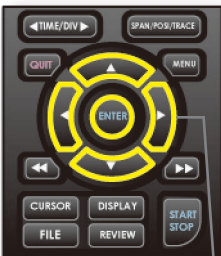

Text input box

Select the text type; delete; insert; confirm

Select the character

(5) A text input box is displayed. Let's create a folder named "TEST".

Input "TEST", move the cursor to , and then press the ENTER key to enter your setting.



- (6) Return to screen (2) and move the cursor to the  icon to select the created folder and then press the ENTER key.
- (7) Move the cursor to **OK** and then press the ENTER key.



When this setting has been completed, data will be captured and saved to the <TEST> folder in the internal memory with an automatic file name.

- (8) Available space in specified memory device and time for data capture are displayed in the lower part of the Record Settings menu. The data capture time can be checked.

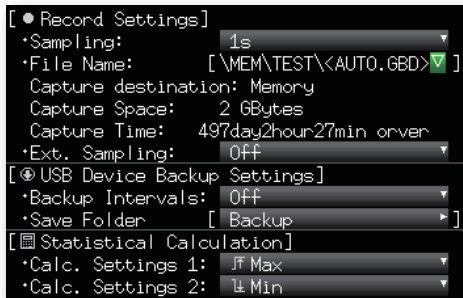

Minimum required setting for data capture is completed.

### 3. Data Capture: How to Capture Data

All of setting for the data capture have been set, capturing data can be started now. During the data capture operation, let's also replay some data that was captured previously.

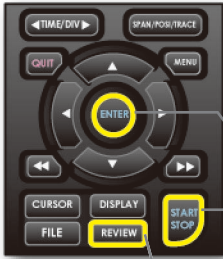

#### 1. Starting data capture

- (1) Press the START/STOP key.
- (2) A confirmation message is displayed.



- (3) Press the ENTER key to start data capture.

#### 2. Screen status during data capture

Once data capture has started, progress of data capture is shown. The displayed time is counting up or down.



elapsed time

remaining time for data capture

(The indication becomes ++++ when the data capture time is 9999 hours or more.)

Points to Remember!



Data can be replayed while being captured by pressing the REVIEW key. Data can be replayed during the data capture operation from the beginning to the point that has been captured. During the replay, you can check arbitrary level values and such by moving the cursor. You can return to the data capture screen by pressing the REVIEW key again.

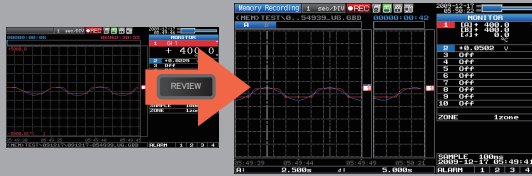

#### 3. Stopping data capture

Press the START/STOP key to end the data capture operation.

- (1) Press the START/STOP key.



- (2) A confirmation message is displayed. Press the ENTER key.
- (3) Data capture ends, and the GL220 goes into the Free Running status.

The operation of data capture is completed.

## 4. Data Replay : How to Replay Captured Data

When data capture ends, data is automatically replayed. The automatically replayed data is the data captured to the internal memory which has been set as the data capture destination. Press the QUIT key to end the data replay operation.

**1. Selecting a file to replay**

(1) Press the REVIEW key.  
 (2) Since the file you want to replay has the file name that was appended automatically when the data was captured, move the cursor to the OK button and then press the ENTER key.  
 (3) The Replay screen opens.

**2. Replay screen**



**1. Scroll bar**

**2. Level display area**

**3. Quick settings**

**4. Time display**

**5. Cursor**

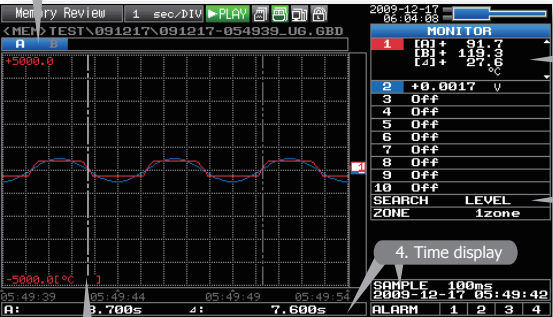

- (1) Scroll bar : Displays the position within the whole data and the display width.
- (2) Level display area : Displays the levels of A and B cursors and the difference between the A and B values.
- (3) Quick settings : Use the ◀▶ keys to search the previous or next level. (Note: Make search settings in the menu.)
- (4) Time display : Displays the sampling interval and the time of the cursor.
- (5) Cursor : Displays the cursor. (Note: Press the CURSOR key to switch between A and B cursors.)  
 Move the cursor using the ◀▶ keys or the ◀▶▶ keys.  
 Desired level values and time can be checked by moving the cursor.

Press the QUIT key to end the data replay operation.  
 A confirmation message is displayed. Press the ENTER key.



Data replay ends, and the GL220 goes into the Free Running status.

Explanation of basic operation in the GL220 is completed. The GL220 has many other convenient functions. Please refer the next five pages for details.

# GL220 Convenient Functions

The GL220 has various functions that enable it to be used more effectively. The selected three functions are described with details in the following.

## Trigger Functions to Control Data Capture Start/Stop Operations

Trigger functions can be used to control the timing of the start of a data capture operation, and the timing of the end of a data capture operation.



For example...  
The trigger function performs operations such as the following:

- Start data capture when the voltage exceeds 1 V
- Stop data capture at 1:00 pm
- Perform control via external input

Here data capture is started in the condition as "Start data capture when the CH 1 temperature exceeds 20°C".

(1) Press the MENU key and open the "TRIG" menu.

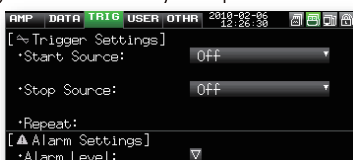

(2) Move the cursor to "Start Source" and select "Level".



(3) Move the cursor to the "Mode" parameter for the CH 1, and then select "Hi".

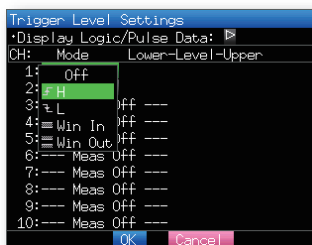



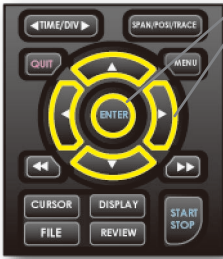

- (4) Move the cursor to the "Level" parameter next to the "Mode" parameter and then press the ENTER key.
- (5) The input box shown in the following screen is displayed. Select "20". Use the  $\leftarrow$  and  $\rightarrow$  keys to move to the cursor to the second digit from the right, and the  $\uparrow$  and  $\downarrow$  keys to change the value. Press the ENTER key.

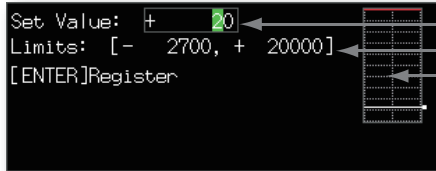

- Numerical value input box
- Lower and upper limit for setting.
- Waveform area for confirmation
- Use the  $\uparrow$  and  $\downarrow$  keys to change the values.
- Use the  $\leftarrow$  and  $\rightarrow$  keys to move the digit.
- Use the ENTER key to enter the value.
- Use the QUIT key to cancel the setting.

- (6) When the screen changes to the following screen, move the cursor to the **OK** button and then press the ENTER key.

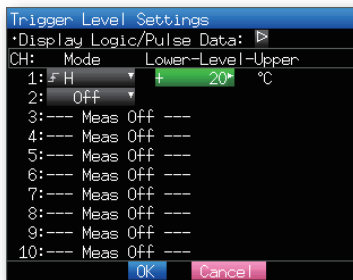

- (7) The screen returns to the TRIG menu screen. Press the QUIT key to return the GL220 to the Free Running status.
- (8) Press the START/STOP key to start data capture. If the trigger condition has not been satisfied, the GL220 goes into the "Armed" status as shown on the following screen.



When the trigger condition has been satisfied, data capture starts and the "Memory Recording" is displayed. Elapsed time for data capture appears.



## Span, Position and Trace Functions to Adjust the Waveform Display

These functions enable to make adjustments in order to view individual channels more easily, and to delete waveforms that is not required to view in display.

Points to Remember



The span, position and trace operations can be performed while the GL220 is in the Free Running status, while it capturing data, and while it is replaying data. The changes are applied to the displayed data only, the change is not affected to the captured data.

### 1. How to Make a Span setting

The Span parameter is used to adjust the amplitude of the input waveform. This setting is made in the aforementioned Free Running status.

- (1) Set the displayed span for CH 1 to 100°C.
- (2) Press the SPAN/POSITION/TRACE key to select the SPAN mode.

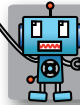

The currently selected mode (SPAN, POSITION or TRACE) can be checked by looking at the "Waveform Operation Display Area".

- (3) Use the  $\blacktriangledown$  and  $\blacktriangle$  keys to make CH 1 active (enlarged display).
- (4) Use the  $\blacktriangleleft$  and  $\blacktriangleright$  keys to change the Span value. Here the value for span is set to 100°C. When this setting has been changed, the waveform screen scale will be set to "+100.0 to +0.0".

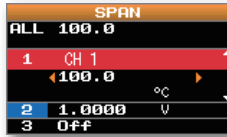

### 2. How to make a Position setting

The Position parameter is used to adjust the position of displayed waveform that is set by the upper and lower values.

- (1) Press the SPAN/POSITION/TRACE key to select the POSITION mode.
- (2) Use the  $\blacktriangledown$  and  $\blacktriangle$  keys to make CH 1 active (enlarged display).
- (3) Use the  $\blacktriangleleft$  and  $\blacktriangleright$  keys to set the Position value to "+80°C to -20°C".

When this setting has been changed, the waveform screen scale will be set to "+80°C to -20°C".

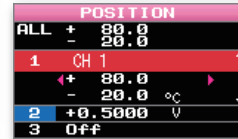

### 3. How to make a Trace setting.

The Trace parameter can be used to specify the selected waveform to be visible or invisible on the display.

- (1) Press the SPAN/POSITION/TRACE key to select the TRACE mode.
- (2) Use the  $\blacktriangledown$  and  $\blacktriangle$  keys to make CH 1 active (enlarged display).
- (3) Use the  $\blacktriangleleft$  and  $\blacktriangleright$  keys to select Off.

When this setting has been changed, the CH 1 waveform is not displayed.



# GL220 Specifications

## Standard Specifications

Item	Description																										
Number of analog Channels	10																										
External input and output functions	Trigger input and External sampling (1ch), Logic input (4ch) or Pulse input (4ch), Alarm output (4ch)																										
PC interface	USB (FullSpeed supported) provided as standard features																										
Built-in memory device	Internal memory: 2GB or more USB memory slot (FullSpeed supported) is provided as a standard feature																										
Sampling interval	10ms/1ch MAX 10*/20*/50*/100/125/200/250/500ms/1/2/5/10/20/30sec/ 1/2/5/10/20/30min/1hour/External Note: Interval setting below 50 ms is available depending on the input settings and the number of measurement channels.																										
Back-up functions	Setup parameters: EEPROM/Clock: Lithium battery																										
Clock accuracy (ambient temperature 23°C)	±0.002% (approx. 50 seconds per month)																										
Operating environment	0~45°C, 5~85%RH (0 to 40°C when operated in batteries/15 to 35°C when battery is charging)																										
Power supply	AC adapter : 100 to 240 VAC, 50 to 60 Hz DC input : 8.5 to 24 VDC(26.4 V max.) Battery pack (option) : 7.4 VDC (2200 mAh), 17Wh one pack required																										
Power consumption	AC power consumption (*when using the AC adapter provided as a standard accessory)																										
	<table border="1"> <thead> <tr> <th>No</th> <th>Condition</th> <th>Normal</th> <th>During recharging battery</th> </tr> </thead> <tbody> <tr> <td>1</td> <td>When the LCD is on</td> <td>12VA</td> <td>29VA</td> </tr> <tr> <td>2</td> <td>When the screensaver is operating</td> <td>11VA</td> <td>28VA</td> </tr> </tbody> </table>	No	Condition	Normal	During recharging battery	1	When the LCD is on	12VA	29VA	2	When the screensaver is operating	11VA	28VA														
	No	Condition	Normal	During recharging battery																							
	1	When the LCD is on	12VA	29VA																							
	2	When the screensaver is operating	11VA	28VA																							
	DC current consumption																										
	<table border="1"> <thead> <tr> <th>No</th> <th>Condition</th> <th>Normal</th> <th>During recharging battery</th> </tr> </thead> <tbody> <tr> <td>1</td> <td>When the LCD is on</td> <td>0.18A</td> <td>0.6A</td> </tr> <tr> <td>2</td> <td>+24V When the screensaver is operating</td> <td>0.15A</td> <td>0.57A</td> </tr> <tr> <td>3</td> <td>When the LCD is on</td> <td>0.31A</td> <td rowspan="2">Recharging battery is not possible.</td> </tr> <tr> <td>4</td> <td>+12V When the screensaver is operating</td> <td>0.26A</td> </tr> <tr> <td>5</td> <td>When the LCD is on</td> <td>0.45A</td> <td rowspan="2">Recharging battery is not possible.</td> </tr> <tr> <td>6</td> <td>+8.5V When the screensaver is operating</td> <td>0.37A</td> </tr> </tbody> </table>	No	Condition	Normal	During recharging battery	1	When the LCD is on	0.18A	0.6A	2	+24V When the screensaver is operating	0.15A	0.57A	3	When the LCD is on	0.31A	Recharging battery is not possible.	4	+12V When the screensaver is operating	0.26A	5	When the LCD is on	0.45A	Recharging battery is not possible.	6	+8.5V When the screensaver is operating	0.37A
	No	Condition	Normal	During recharging battery																							
	1	When the LCD is on	0.18A	0.6A																							
	2	+24V When the screensaver is operating	0.15A	0.57A																							
3	When the LCD is on	0.31A	Recharging battery is not possible.																								
4	+12V When the screensaver is operating	0.26A																									
5	When the LCD is on	0.45A	Recharging battery is not possible.																								
6	+8.5V When the screensaver is operating	0.37A																									
*Normal condition: LCD brightness is set to MAX.																											
External dimensions	194×117×42mm																										
Weight	520g (*Excluding the AC adapter and battery packs)																										
Vibration-tested conditions	Equivalent to automobile parts Type 1 classification																										

## External Input/Output Functions

Item	Description
Input specifications (pulse/logic, trigger/External sampling)	Maximum input voltage : 0 to +24V(single-ended ground input)
	Input threshold voltage : approx. +2.5 V
	Hysteresis : approx. 0.5 V (+2.5 V to +3 V)
Alarm output specifications	Output format : Open collector output (5 V, 10 kΩ pull-up resistance)
Refer to the User's Manual in the supplied CD-ROM for more information.	

# Input Unit Specifications

Item	Description																																															
Number of input channels	M3 screw type, 10 channels																																															
Method	Photo MOS relay scanning system, all channels isolated, balanced input																																															
Maximum sampling speed	10ms/1ch																																															
Measurement accuracy	Voltage 20m/50m/100m/200m/500m 1/2/5/10/20/50/1-5V F.S.																																															
	Temperature K, J, E, T, R, S, B, N, W (WRe5-26)																																															
	Humidity 0 to 100% (voltage 0 V to 1 V scaling conversion) *with B-530 (option)																																															
Measurement accuracy *1 (23°C±5°C) - When 30 minutes or more have elapsed after power was switched on - Sampling 1s/10ch - Filter ON (10) - GND connected	Voltage ±0.1% of F.S.																																															
	Thermocouple																																															
	<table border="1"> <thead> <tr> <th>Type</th> <th>Measurement Temperature Rang</th> <th>Measurement Accuracy</th> </tr> </thead> <tbody> <tr> <td rowspan="4">R/S</td> <td>0≤TS≤100</td> <td>±5.2°C</td> </tr> <tr> <td>100&lt;TS≤300</td> <td>±3.0°C</td> </tr> <tr> <td>R: 300&lt;TS≤1600</td> <td>±(0.05% of rdg +2.0°C)</td> </tr> <tr> <td>S: 300&lt;TS≤1760</td> <td>±(0.05% of rdg +2.0°C)</td> </tr> <tr> <td rowspan="2">B</td> <td>400≤TS≤600</td> <td>±3.5°C</td> </tr> <tr> <td>600&lt;TS≤1820</td> <td>±(0.05% of rdg +2.0°C)</td> </tr> <tr> <td rowspan="2">K</td> <td>-200≤TS≤-100</td> <td>±(0.05% of rdg +2.0°C)</td> </tr> <tr> <td>-100&lt;TS≤1370</td> <td>±(0.05% of rdg +1.0°C)</td> </tr> <tr> <td rowspan="2">E</td> <td>-200≤TS≤-100</td> <td>±(0.05% of rdg +2.0°C)</td> </tr> <tr> <td>-100&lt;TS≤800</td> <td>±(0.05% of rdg +1.0°C)</td> </tr> <tr> <td rowspan="2">T</td> <td>-200≤TS≤-100</td> <td>±(0.1% of rdg +1.5°C)</td> </tr> <tr> <td>-100&lt;TS≤400</td> <td>±(0.1% of rdg +0.5°C)</td> </tr> <tr> <td rowspan="3">J</td> <td>-200≤TS≤-100</td> <td>±2.7°C</td> </tr> <tr> <td>-100&lt;TS≤100</td> <td>±1.7°C</td> </tr> <tr> <td>100&lt;TS≤1100</td> <td>±(0.05% of rdg +1.0°C)</td> </tr> <tr> <td>N</td> <td>0≤TS≤1300</td> <td>±(0.1% of rdg +1.0°C)</td> </tr> <tr> <td>W</td> <td>0≤TS≤2000</td> <td>±(0.1% of rdg +1.5°C)</td> </tr> <tr> <td>Reference contact compensation accuracy</td> <td>±0.5°C</td> </tr> </tbody> </table>	Type	Measurement Temperature Rang	Measurement Accuracy	R/S	0≤TS≤100	±5.2°C	100<TS≤300	±3.0°C	R: 300<TS≤1600	±(0.05% of rdg +2.0°C)	S: 300<TS≤1760	±(0.05% of rdg +2.0°C)	B	400≤TS≤600	±3.5°C	600<TS≤1820	±(0.05% of rdg +2.0°C)	K	-200≤TS≤-100	±(0.05% of rdg +2.0°C)	-100<TS≤1370	±(0.05% of rdg +1.0°C)	E	-200≤TS≤-100	±(0.05% of rdg +2.0°C)	-100<TS≤800	±(0.05% of rdg +1.0°C)	T	-200≤TS≤-100	±(0.1% of rdg +1.5°C)	-100<TS≤400	±(0.1% of rdg +0.5°C)	J	-200≤TS≤-100	±2.7°C	-100<TS≤100	±1.7°C	100<TS≤1100	±(0.05% of rdg +1.0°C)	N	0≤TS≤1300	±(0.1% of rdg +1.0°C)	W	0≤TS≤2000	±(0.1% of rdg +1.5°C)	Reference contact compensation accuracy	±0.5°C
	Type	Measurement Temperature Rang	Measurement Accuracy																																													
	R/S	0≤TS≤100	±5.2°C																																													
		100<TS≤300	±3.0°C																																													
		R: 300<TS≤1600	±(0.05% of rdg +2.0°C)																																													
		S: 300<TS≤1760	±(0.05% of rdg +2.0°C)																																													
	B	400≤TS≤600	±3.5°C																																													
		600<TS≤1820	±(0.05% of rdg +2.0°C)																																													
K	-200≤TS≤-100	±(0.05% of rdg +2.0°C)																																														
	-100<TS≤1370	±(0.05% of rdg +1.0°C)																																														
E	-200≤TS≤-100	±(0.05% of rdg +2.0°C)																																														
	-100<TS≤800	±(0.05% of rdg +1.0°C)																																														
T	-200≤TS≤-100	±(0.1% of rdg +1.5°C)																																														
	-100<TS≤400	±(0.1% of rdg +0.5°C)																																														
J	-200≤TS≤-100	±2.7°C																																														
	-100<TS≤100	±1.7°C																																														
	100<TS≤1100	±(0.05% of rdg +1.0°C)																																														
N	0≤TS≤1300	±(0.1% of rdg +1.0°C)																																														
W	0≤TS≤2000	±(0.1% of rdg +1.5°C)																																														
Reference contact compensation accuracy	±0.5°C																																															
*1: Thermocouple diameters T: 0.32 Φ, others: 0.65 Φ																																																
A/D converter	16-bit Delta-Sigma A/D converter (Effective resolution: approx. 1/40,000 of ± range)																																															
Temperature coefficient	Gain : 0.01% of F.S./°C Zero : 0.02% of F.S./°C      Occurs when sampling speed is 10, 20, or 50 ms.																																															
Maximum input voltage	Between +/- terminals : 60Vp-p																																															
	Between input terminal/input terminal : 60Vp-p																																															
	Between input terminal/GND : 60Vp-p																																															
Withstand voltage	Between input terminal/input terminal : 1 minute at 350Vp-p																																															
	Between input terminal/GND : 1 minute at 350Vp-p																																															
Common mode rejection ratio	At least 90 dB (50/60 Hz; signal source 300Ω or less)																																															
Noise	At least 48 dB (with +/- terminals shorted)																																															

# GL220 APS Installation Guide

This guide describes how to install the GL220 application software.

## System Requirements

This software can be installed on a PC which fulfills the following conditions.

OS	: WindowsXP, WindowsVista, Windows 7
CPU	: Pentium4 1.7GHz or higher
Memory	: 256MB or more (512MB or more recommended)
HDD	: 200MB (1GB recommended) additional space required for installing the application software
Display	: Resolution 1024 x 768 or higher, 65535 colors or above (16 Bit or higher)
Others	: CD-ROM drive (for installing from CD), USB port required

## To Install the USB Driver

To connect this unit to a PC with the USB interface, a USB driver must be installed in the PC.

A USB driver and the USB driver installation manual are stored on the supplied CD-ROM. Install the USB driver according to this manual.

(The manual location: D:\USB Driver\English\GL-USB-UM152.PDF)

Note: D: drive name of CD-ROM. The letter of CD-ROM drive vary it with the CD-ROM drive of your PC.

## To Install GL220 Application Software

To install the application software which sets and controls the GL220, follow the directions below.

1. Insert the accompanying midi LOGGER GL220 CD-ROM in the PC's CD drive. Select [Start] -> [Run] to open the [Run] window.
2. In the [Open:] field, type in "D:\English\GL220\_820APS\SETUP.EXE" and press [OK].
3. The installer starts.  
("D:" represents the CD-ROM drive. Change this letter to the drive letter representing your CD-ROM drive, if necessary.)
4. Follow all directions displayed by the installer to continue.

Note: D: drive name of CD-ROM. The letter of CD-ROM drive vary it with the CD-ROM drive of your PC.

# GRAPHTEC

Specifications are subject to change without notice.

GL220 Quick Start Guide  
(GL220-UM-852)

November 1, 2012  
2nd edition-01

Publisher GRAPHTEC CORPORATION